

# Data Sheet



Article number: 2310320071

Description: E+G Square end-cap  
NDX.Q-40x1.2-M8

## Measures

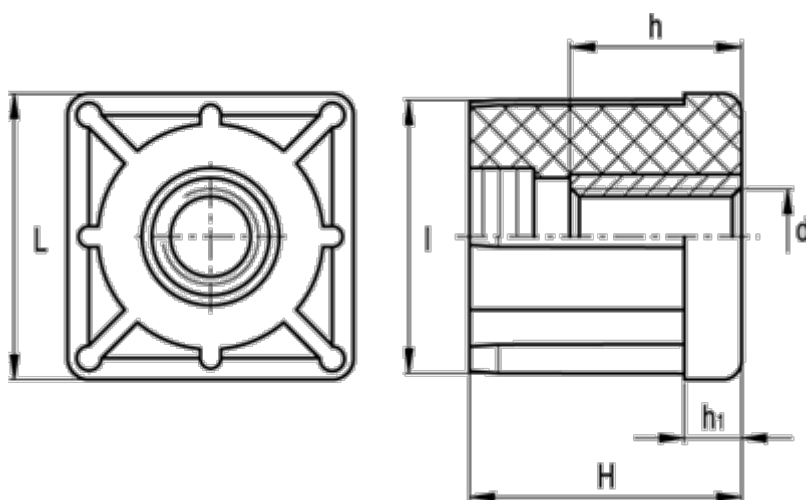

d	= M8	Tube wall thickness = 1.2
h	= 10	Weight (g) = 47
H	= 38	
h1	= 8	
Internal tube size	= 37.6	
l	= 37.6	
L	= 40	
Outer tube size	= 40	